



DYNACORD®

cobra-4

cobra

Compact Line Array
Systems

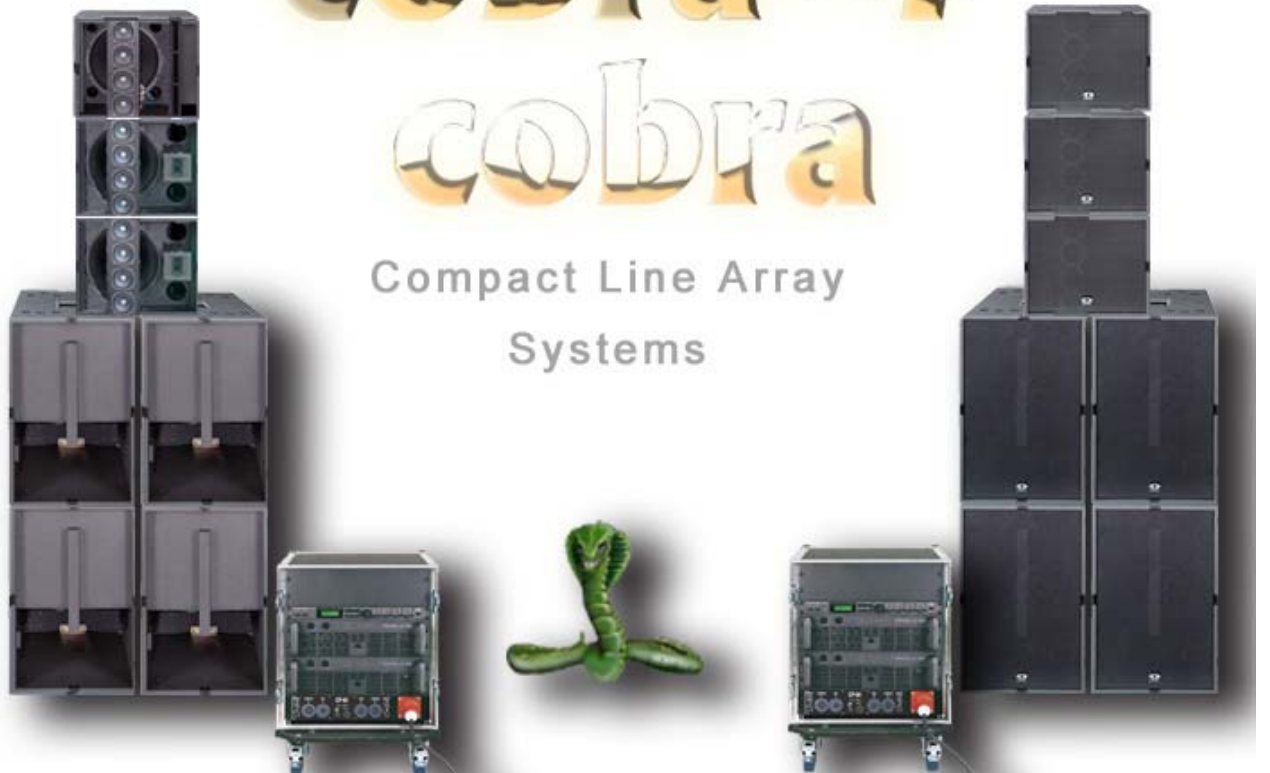

HANDBOOK



TABLE OF CONTENTS

01. GENERAL	PAGE 01
02. COBRA SYSTEM / COBRA-4 SYSTEM	PAGE 02
03. SETTING UP	PAGE 03
04. TIPS ON SETTING UP	PAGE 04
05. AIMING	PAGE 05
06. COBRA SYSTEM CONFIGURATIONS (SUB / PWH)	PAGE 06
07. COBRA-4 SYSTEM CONFIGURATION (TOP / PWH)	PAGE 07
08. COBRA-4 SYSTEM (BASIC SET)	PAGE 08
09. COBRA-4 EXPANSION	PAGE 09
10. COBRA SYSTEM AMP RACKS	PAGE 10
11. FLYING ACCESSORIES	PAGE 11
12. COBRA SYSTEM COUNTRY SPECIFIC VERSIONS	PAGE 12
13. TECHNICAL SPECIFICATIONS	PAGE 13

TELEX / EVI Audio GmbH – Hirschberger Ring 45 – D 94315 STRAUBING, FRG – www.dynacord.de

Hans Bürger – Product Manager Dynacord – Office : ++49 (0) 9421 – 70 60 / hans.buerger@telex.de

1. GENERAL

Line arrays have now become the preferred solution in high quality concert sound applications. Line arrays have now become the preferred solution in high quality concert sound applications. On account of their directivity, projection and low distortion, line arrays are considerably more suitable for providing high quality sound reinforcement especially to audience areas that extend widely in the horizontal plane than classical systems with their narrow horizontal dispersion angle.

Conventional line arrays are large, heavy, expensive and extremely costly to set up. They are therefore seldom used for small to medium-sized events despite their advantages in terms of quality.

DYNACORD COBRA compact line array systems on the other hand are extremely compact, simple to set up and extremely cost efficient. They therefore offer line array performance in the type of situations where conventional large line arrays can provide no economically viable solution.

The **extremely wide horizontal dispersion** of the DYNACORD COBRA compact line array system resulting from its generation of quasi-cylindrical sound waves means that it can provide coverage to large audience areas without the destructive interference or 'combing' that bedevils conventional horizontal clusters (see fig. 01).

The shallow and **precisely defined vertical directivity**, free from strong vertical 'side lobes', avoids the undesired radiation of sound towards ceiling and floor areas, eliminating to a large extent the interference produced by reflections (see fig. 02).

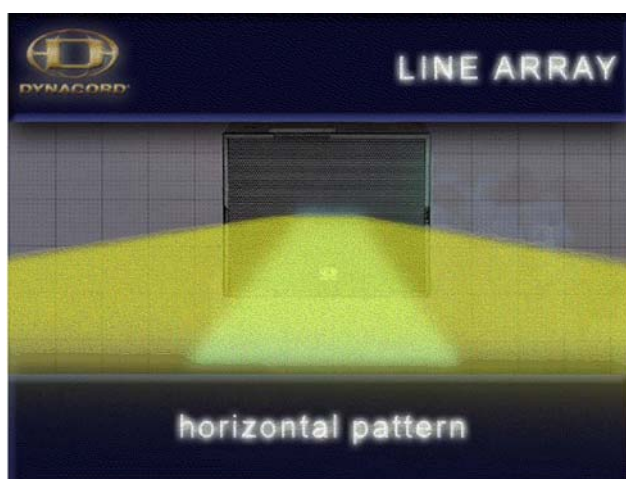

Figure 01

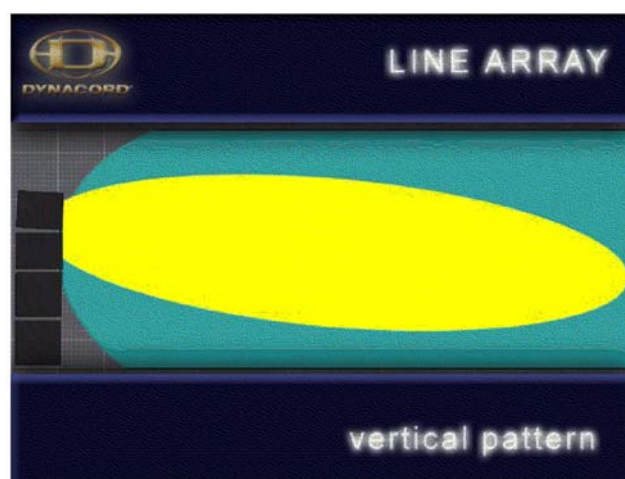

Figure 02

The **nearfield zone** of line array systems extends considerably further than that of classical systems. Noticeably fewer fluctuations in sound pressure level occur in the vicinity of the line array.

The direct sound level of a line array in the nearfield only falls by **some 3 dB** as the distance doubles, whereas with classical systems it falls by 6 dB (twice as fast) in the farfield.

DYNACORD COBRA line array systems can therefore achieve the same sound pressure levels in the most remote sections of the audience area as conventional systems without the need for a sharp increase in sound pressure levels in the areas near the speakers. Since the slope is **markedly shallower**, coverage of the audience area is far more homogeneous and free from the excessively steep increase in SPL directly in front of the PA that is the bugbear of classical systems.

DYNACORD COBRA compact line array systems are therefore extremely low in feedback and even the coverage of the nearfield is far less problematic than that of conventional systems.

2. SYSTEMS

DYNACORD COBRA compact line array systems come in two variations: the “**COBRA SYSTEM**” active 2-way (SUB/TOP) and the “**COBRA-4 SYSTEM**” active 4-way (SUB / LOW / MID /HIGH).

The active 2-way **COBRA SYSTEM** is designed for high quality sound reinforcement for events in smallish marquees and halls over distances of up to 40 metres and audience areas up to around 1000 sq. metres (see fig. 03).

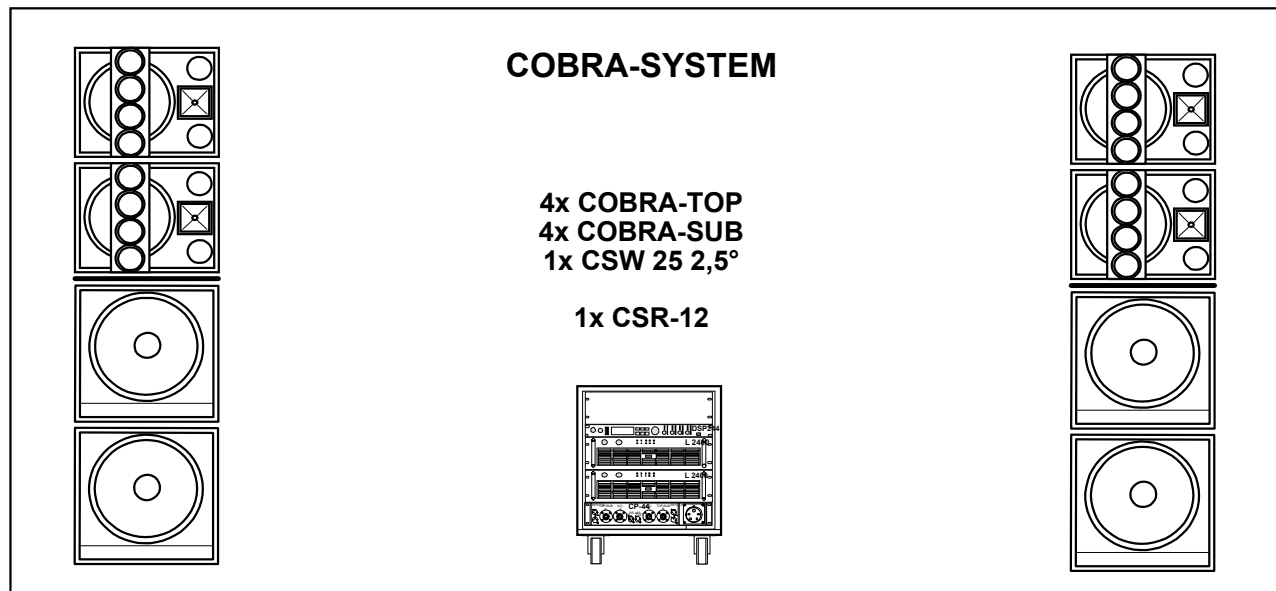

Figure 03

The active 4-way **COBRA-4 SYSTEM** is designed to project over a distance of up to 80 metres in medium-sized marquees, halls and open air events and produces the type of sound pressure levels required by typical TOP 40 bands: 100 dB in the mid/high range and up to 120 dB in the low frequency range at the FOH position, 30 metres from the array (see fig. 04).

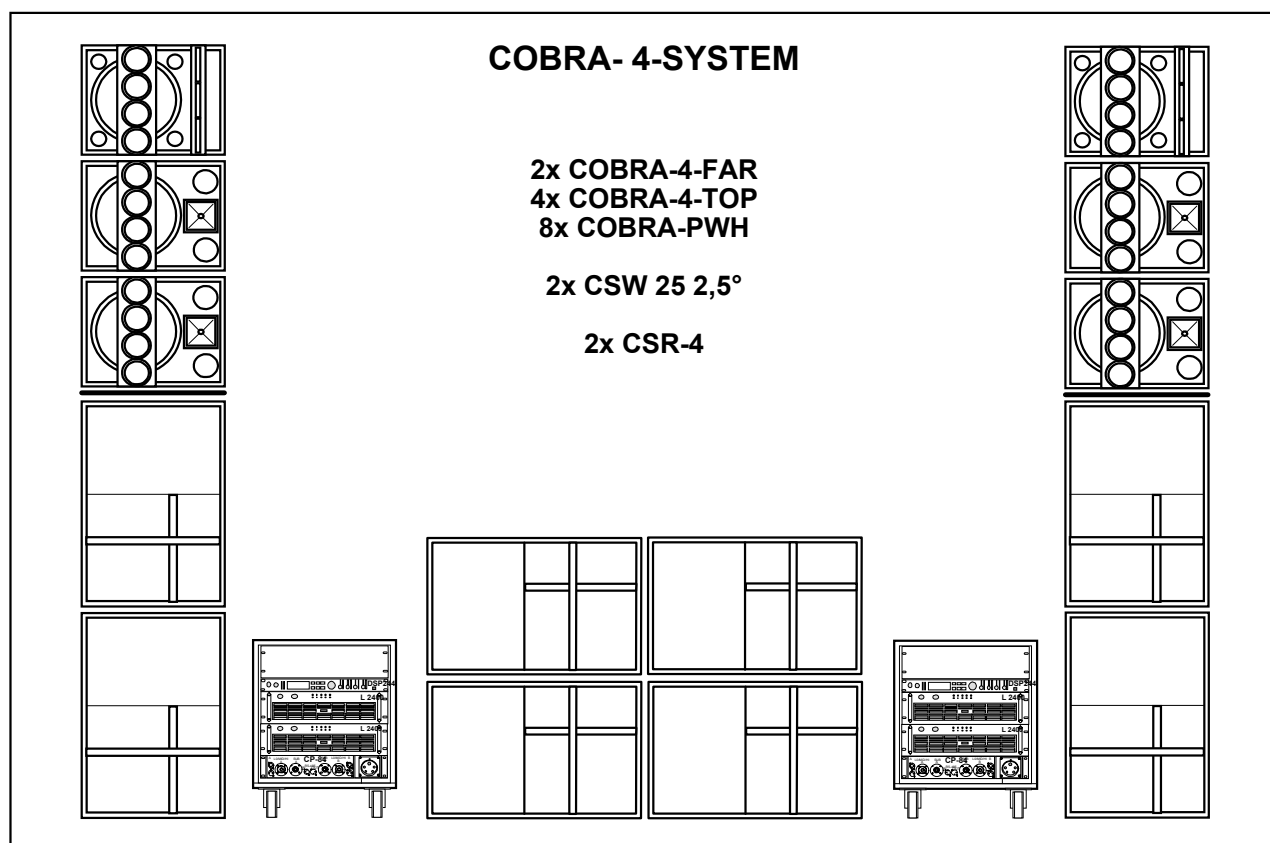

Figure 04

3. SETTING UP

When providing sound reinforcement for medium-sized marquees, multi-function halls and open air events, the question often arises as to whether the enclosures have to be **flown** or whether simple **stacking** of the enclosures near the stage will suffice.

As a rule of thumb, the angle of incidence with regard to the most distant listener should be at least 5°, if excessive attenuation of the sound waves by the audience is to be avoided.

To project over a distance of up to 40 metres, the mid/high enclosures should therefore be at least 3 to 4 metres above the floor level of the audience area (see fig. 05).

It is still normally possible to achieve this by simply stacking the enclosures on the stage. The mid/high enclosures should be tilted towards the furthest third of the audience area.

The 5° criterion is satisfied by such an arrangement up to a distance of around 20 to 30 metres. Beyond that, the sound is too severely attenuated by the audience.

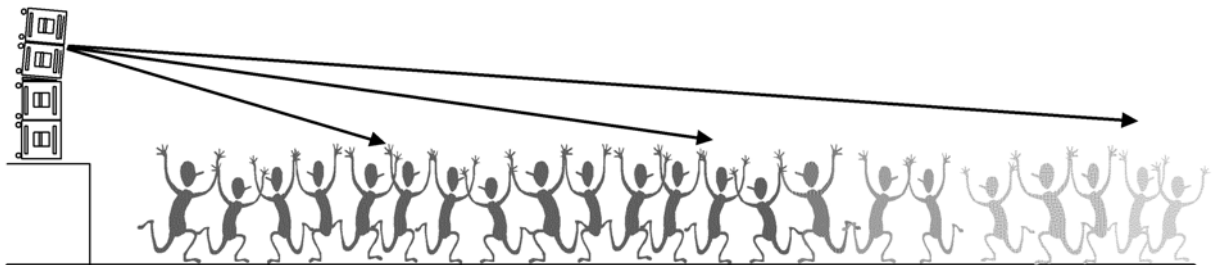

Figure 05

For distances of up to 80 metres, the mid/high enclosures must be between 4 and 6 metres off the ground if an angle of incidence of around 5° with regard to the most distant listeners is to be achieved (see fig. 06).

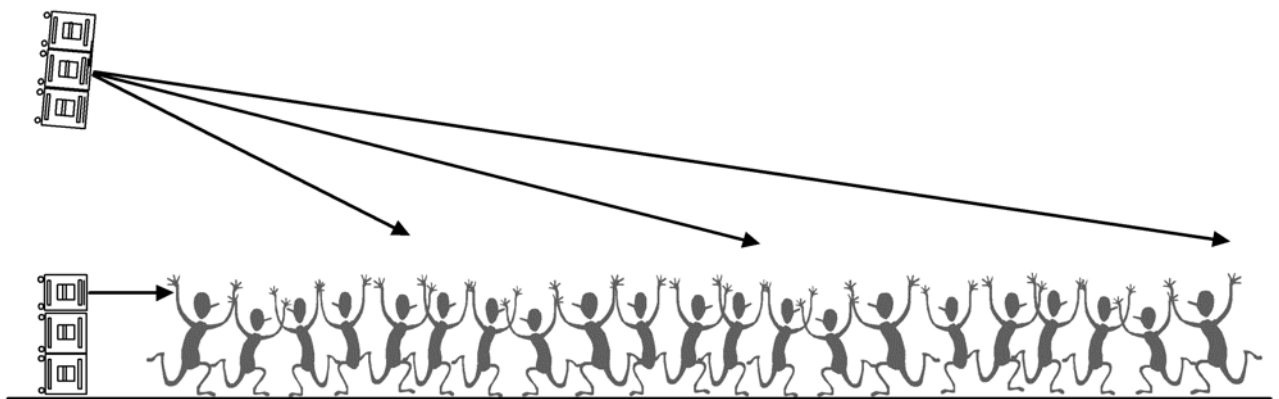

Figure 06

With an unsecured ground stack that is scarcely achievable. The mid/high enclosures must therefore be flown from a truss.

As a result of the shallow vertical directivity of the line arrays, when the systems are flown at a height of 4 to 6 metres, the medium and high frequency ranges only become audible **at a distance of 10 metres** from the stage.

To provide sound reinforcement to the areas directly in front of the stage, a **'front fill'** enclosure with an extremely wide horizontal directivity of around 120° is therefore needed (e.g. 1 x COBRA TOP).

4. TIPS ON SETTING UP

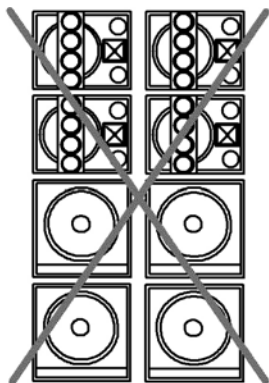

Line array stacks should **never** be positioned **directly alongside each other**.

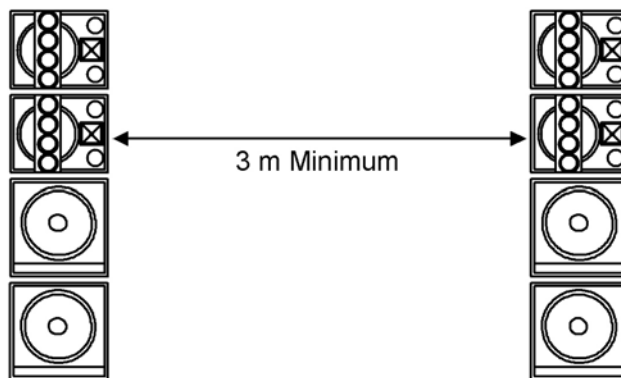

The distance between line array stacks should **never** be **less than 3 metres**

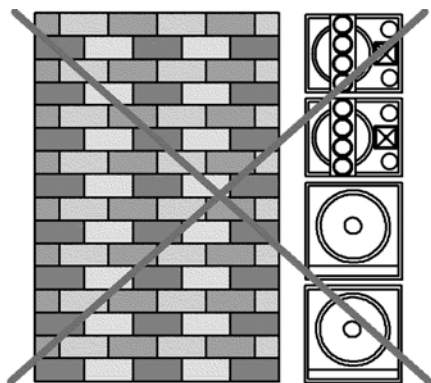

Line array stacks should **never** be positioned **close to a wall or corner**.

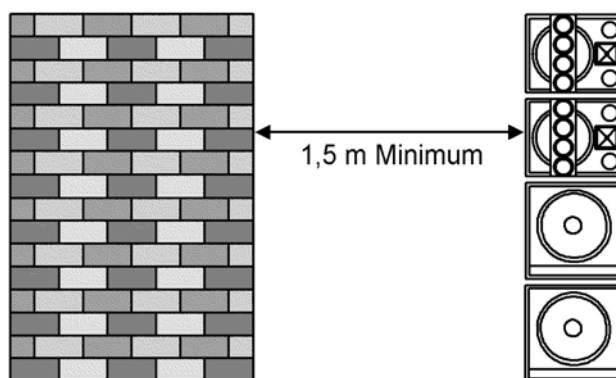

The distance to the nearest wall or corner should **never** be **less than 1.5 metres**.



Stacks should **never** be positioned **at the same level as the heads of the listeners**.

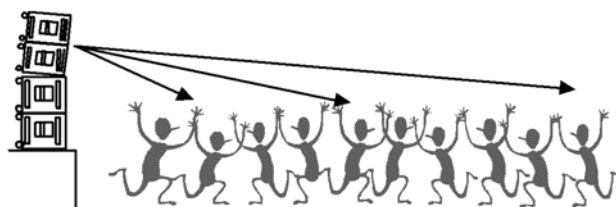

For a distance of up to 40 metres, the top edge of the stack should be around **3 to 4 metres** above the floor.

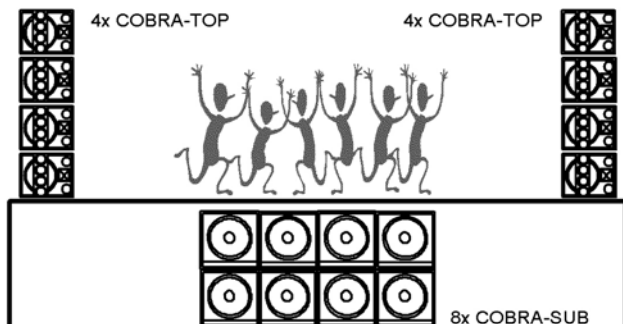

For widely radiating basses use a **central bass cluster**.

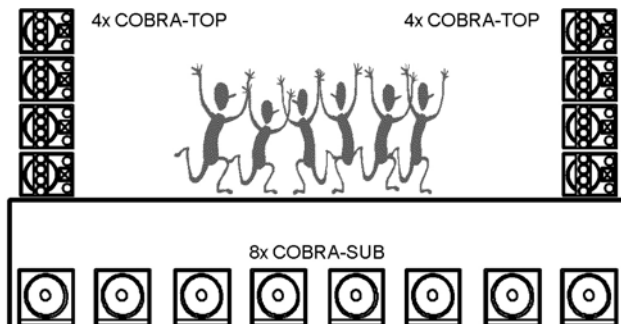

To direct the bass forwards so that it projects further, use a **horizontal bass array**.

5. AIMING

The maximum possible on-axis sound pressure level is achieved through the simple stacking or flying in a straight line of from 2 to 4 COBRA TOPs. Since, however, doubling the number of tops halves the vertical dispersion angle, when setting up using up to the maximum of 4 tops, particular attention must be paid to the way the entire stack is aimed.

		Angle of dispersion
NOTE:	1 x COBRA TOP:	horizontal 120° vertical 30°
	2 x COBRA TOPs stacked vertically	horizontal 120° vertical 15°
	4 x COBRA TOPs stacked vertically	horizontal 120° vertical 7.5°

The following illustrations show the directivity of a stack of four COBRA TOPs in relation to a FOH position at a distance of 20 metres with various arrangements of the speakers.

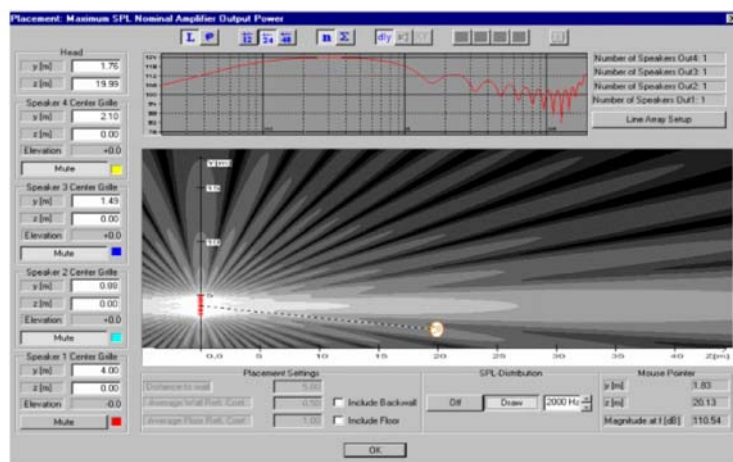

Figure 07

With a straight or stacked arrangement at a height of around 3 to 4 metres the main axis of radiation passes **over the head of the listener** (see fig.07).

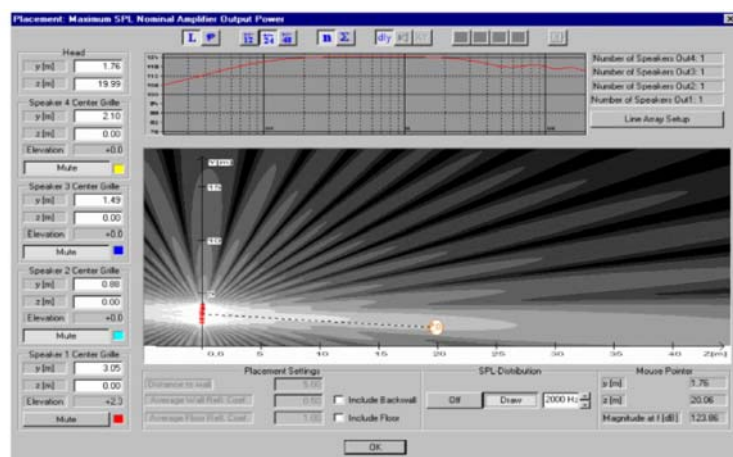

Figure 08

If we now incline the entire stack of 4 enclosures 2 – 3° downwards there is a gain of around + 6 dB in sound pressure levels at the FOH position. (see fig. 08)

The measurements have been done with a line array from omnidirectional point sources with isophase characteristics.

6. CONFIGURATIONS COBRA-SYSTEM (SUB / TOP)

The following illustrations show the basic set of an **active 2-way COBRA SYSTEM** comprising COBRA TOP and COBRA SUB enclosures along with various expansion possibilities. The basic set comprising 4 COBRA TOPs and 4 COBRA SUBs is designed for **high quality sound reinforcement** for events in smallish marquees and halls and for projection over distances of **up to 40 metres** providing coverage for around **1000 square metres**. The COBRA SYSTEM generates a maximum SPL of **137 dB L + 137 dB R** in the mid/high frequency range and up to **141 dB** in the low frequency range.

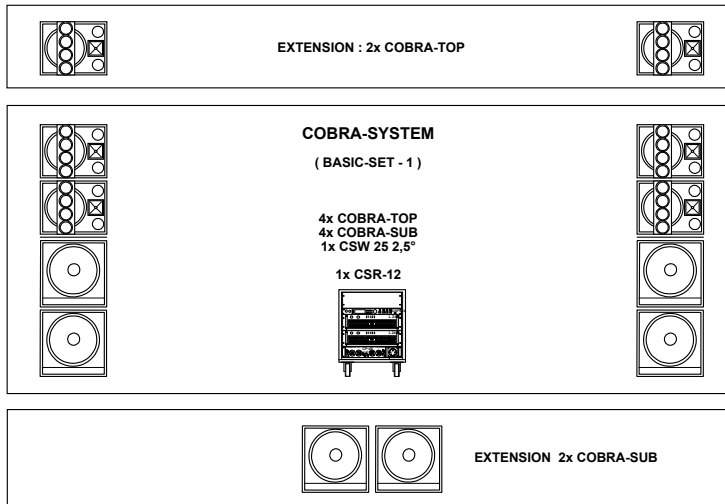

COBRA-SYSTEM Basic set and expansion variations

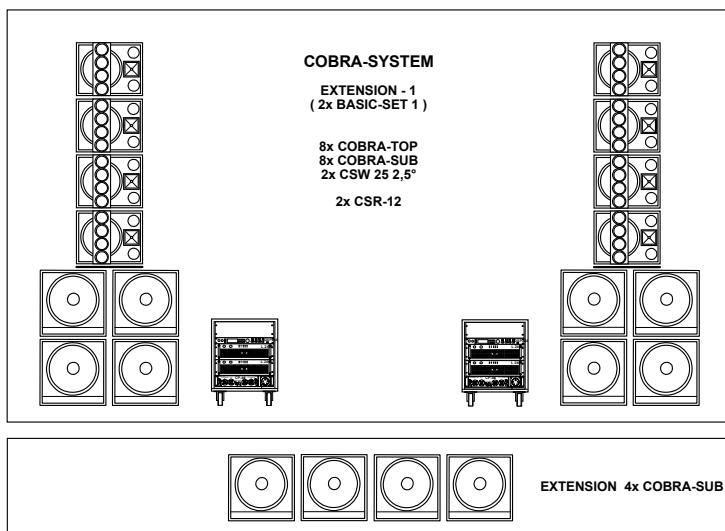

COBRA-SYSTEM maximum sensible expansion variations

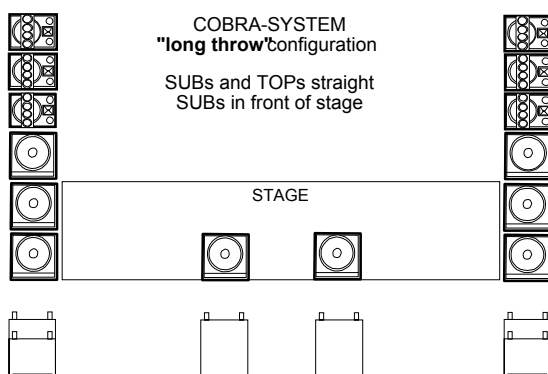

Arrangement for projection over long distances

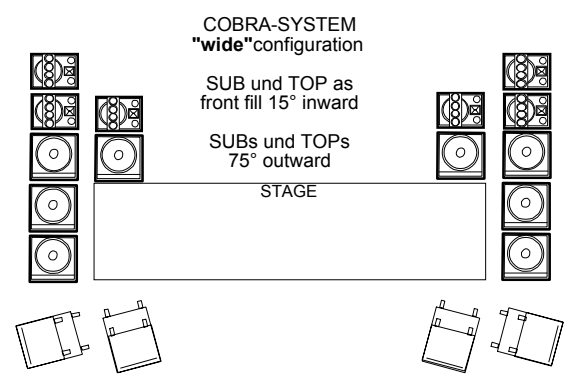

Arrangement for wide coverage

COBRA SYSTEM

The COBRA SYSTEM basic set consists of 4 x COBRA TOPs, 4 x COBRA SUBs, 1 X CSW 25 (2.5° wedge set), a ready-wired amp rack CSR-12 and the appropriate 4-wire system cables for the loudspeaker enclosures.

The integrated DSP 244 controller (stereo 2-way mode) provides the two integrated L2400 power amplifiers with sub and mid/high frequency signals.

The signal from the power amplifiers is available on the Speakon connectors of the integrated CP-44 connector panel. Each stack (L and R) is then powered via a 4-wire system cable, with the signal being looped through from enclosure to enclosure.

Also to be found on the front panel are the XLR sockets for LF control of the rack, the 16A CEE plug for the 3-phase power supply and the XLR In/Out sockets for the RS-485 connection of the DSP 244 (retrofitable).

For maximum expandability, the Cobra Rack CSR-12 offers the possibility of integrating a further power amplifier with 3U (sub-extension or monitor) and their power supply via the CP-44 connector panel

7. CONFIGURATIONS COBRA-SYSTEM (PWH / TOP)

The following illustrations show the basic set of an active 2-way COBRA SYSTEM with the planar waveguide bass horns COBRA PWH as well as various possible arrangements.

The COBRA SYSTEM illustrated below with **4 x COBRA TOPs** and **4 x COBRA PWH** bass horns generates a maximum SPL of 137 dB L + 137 Db R in the mid/high frequency range and up to 144 dB in the low frequency range.

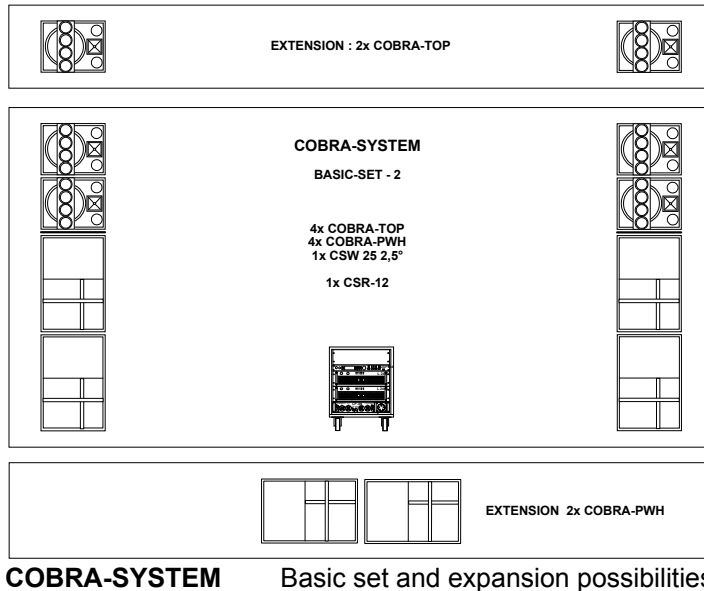

COBRA SYSTEM with COBRA PWH

For especially powerful and far-reaching bass reproduction of a wide variety of styles of music, COBRA PWH bass horns can be integrated into the COBRA SYSTEM.

Two floor-standing COBRA PWHs stacked one on top of the other raise the COBRA TOPs to the required level above the heads of the first few rows of the audience.

Grooves on the top and sides of the enclosures permit a multitude of different arrangements and ensure absolute stability when stacking the enclosures.

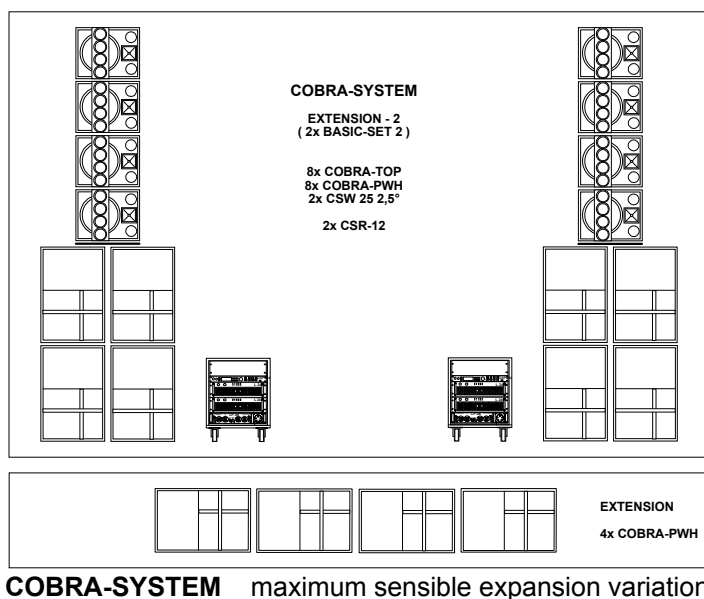

Depending upon the panel configuration, two 8-pin and two 4-pin IN/OUT sockets allow the system to be connected up in active 2-way COBRA SYSTEM (4-pole) and active 4-way COBRA-4 SYSTEM (8-pole) modes using only one system cable per stack.

A maximum of 6 COBRA TOPs and 6 COBRA PWHs can be driven from the CSR-12 amp rack.

The mixing of COBRA SUB and COBRA PWH enclosures is also possible, although optimal results are obtained with bass enclosures of the same type in conjunction with the appropriate preset of the DSP 244 controller.

The “long throw” and “wide” configurations described in Chapter 6 hold good for all types of tops and bass enclosures. **Tops** are arranged in a **horizontally angled** configuration where the need is for particularly **wide coverage** (stage at the long-side) or **stacked vertically** when the need is for coverage **over long distances** (stage at the narrow side).

Bass enclosures are arranged **centrally** in front of the stage (as a bass cluster) when maximum almost omni-directional sound pressure level is called for.

With the typical L / R arrangement alongside the stage, the width should not exceed 6 to 8 metres to avoid destructive interference (or ‘cancelling’) in the area in front of the PA as a result of path length differences. If wider arrangements > 10 metres are called for, it is preferable to spread the bass enclosures along the entire width of the stage to form a horizontal bass array. With this configuration, maximum projection and a more even distribution of the low frequency range across the entire width of the audience area is achieved without pronounced cancellation due to path length differences to the various bass enclosures.

The active 4-way **COBRA-4 SYSTEM** is designed for distances of **up to 80 metres** in medium-sized marquees, halls and open air events and produces the SPL at the **FOH position 30 metres** away typically required by TOP 40 bands: **110 dB** in the mid/high- and up to **120 dB** in the low frequency range.

The maximum SPL of the system at 1 metre is 140 dB L + 140 dB R in the mid/high frequency range and with bass horns arranged in a central cluster up to 150 dB in the low frequency range.

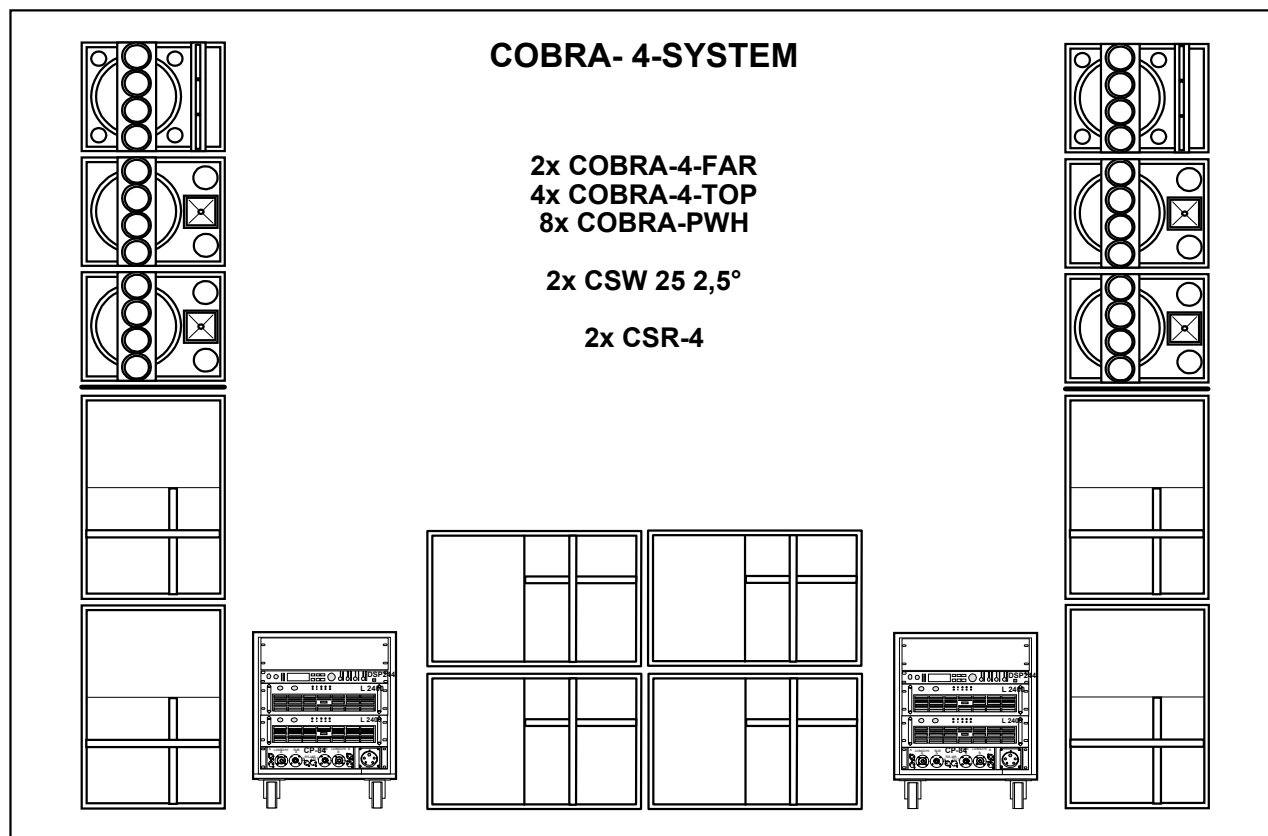

The illustration shows the COBRA-4 SYSTEM consisting of 2 x COBRA-4 FARs, 4 X COBRA-4 TOPs, 2 x CSW 25 wedge sets and 2 x CSR-4 amp racks as well as the appropriate system cable set.

Through the use of 2 x COBRA-4 TOPs and 1 x COBRA-4 FAR per side, even in the typical stacked configuration optimal line array performance can be achieved without expensive adjustments.

The high frequency range in the nearfield of the PA is particularly widely dispersed by the COBRA-4 TOP and therefore reaches the area directly in front of the stage.

For long distances, the COBRA-4 FAR is used. This is placed at the top of the array and has a horizontal directivity of 90° and a vertical directivity of 5° in the high frequency range. In the low frequency and mid ranges, the same components as those of the COBRA-4 TOP are used, thereby providing the optimal extension to the low and midrange line array.

In all, eight COBRA PWH bass horns are used to produce the power and projection in the bass region demanded by TOP 40 bands and can be stacked or employed as a horizontal line array depending upon the requirements of the venue. A variety of grooves are provided on the top and sides of the enclosures to allow maximum flexibility (see chapters 6 and 7).

The COBRA-4 SYSTEM is powered via ready cabled CSR-4 amp racks stationed alongside the enclosures. These contain a DSP 244 controller, 2x L 2400 and CP-84 connector panel.

The cabling of the active 4-way COBRA-4 SYSTEMS is done through the CP-84 panel via 8-wire system cables for the COBRA-4 TOP and COBRA-4 FAR enclosures whilst the COBRA PWH bass horns are connected using 4-pins.

9. COBRA-4 EXPANSION STAGES

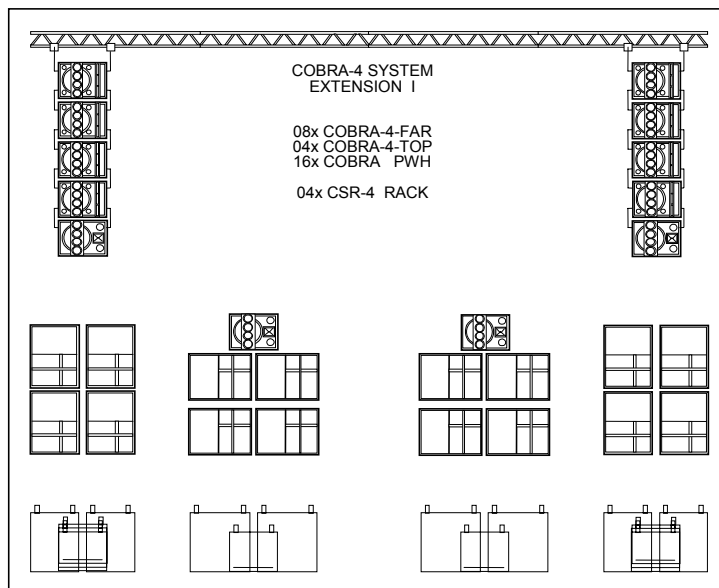

The illustration shows a medium-sized COBRA-4 configuration consisting of one COBRA-4 SYSTEM per side.

Each of the 2 COBRA-4 TOP enclosures occupying the lowest positions on the rig are angled 5° downwards, whilst the upper COBRA-4 TOP and the two COBRA-4 FAR enclosures are flown one on top of the other in a straight line. The middle axis of the three highest enclosures is aimed at the rear third of the audience area by means of a rigging belt.

When the two side arrays are a long way apart, it can make sense to position additional COBRA TOPs on top of the COBRA PWH enclosures comprising the horizontal bass array to cover the area directly in front of the stage.

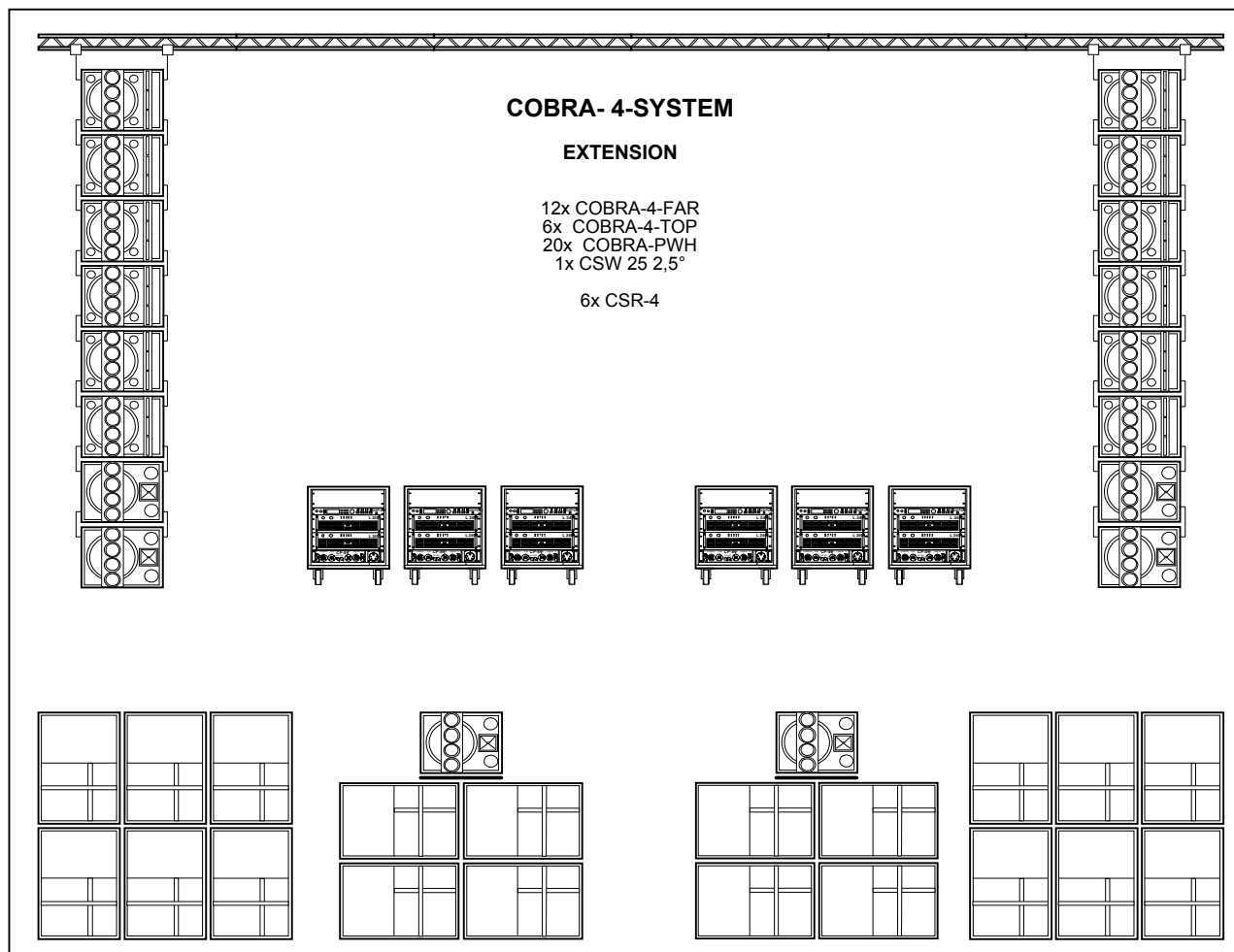

This illustration shows the typical open air arrangement of a COBRA-4 SYSTEM. It consists of the COBRA-4 basic set and modular extensions in the form of additional COBRA-4 FAR and COBRA PWH enclosures with the CSR-4 amp racks configured accordingly. The flown enclosures in the rig are arranged in a 'hockey stick' shape and the complete wing is directed towards the rear third of the audience area using the rigging belt.

10. SYSTEM AMP RACKS

The two illustrations show the internal cabling of the **COBRA SYSTEM RACK** from the rear. The control of the active **2-way COBRA** and active **4-way COBRA-4 SYSTEMS** is effected by their respective system racks (CSR-12 in the case of the COBRA SYSTEM and CSR-4 in the case of the COBRA-4 SYSTEM) which come pre-wired and factory-programmed.

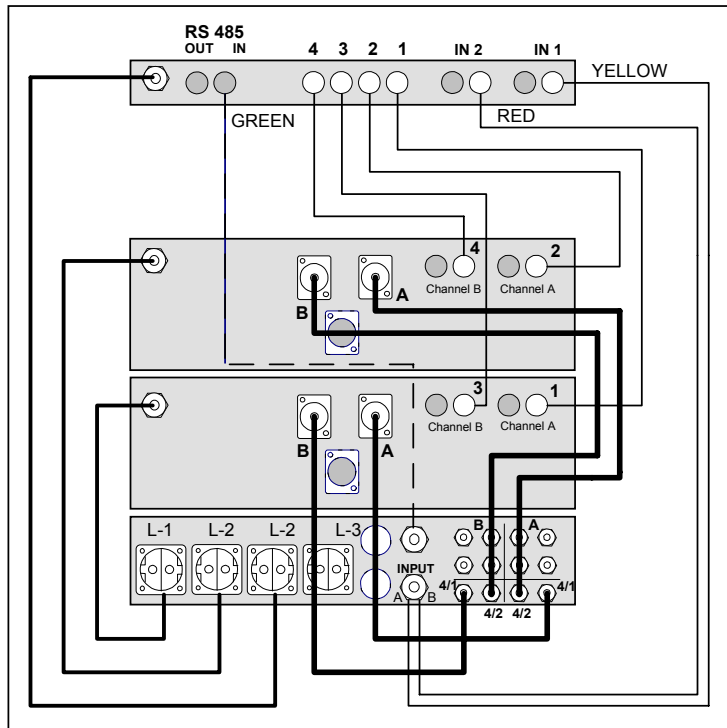

COBRA SYSTEM RACK CSR-12

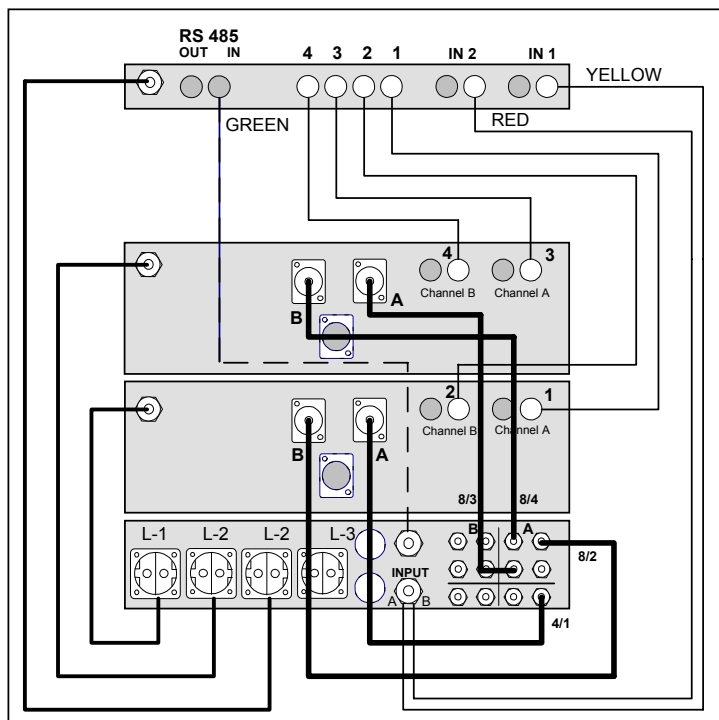

COBRA-4 SYSTEM RACK CSR-4

In the **CSR-12**, the DSP 244 controller operates in stereo 2-way mode and provides the integrated L 2400 power amplifiers with sub and mid/high signals.

The output signals of the L 2400 power amplifiers (TOP above and SUB below) are connected internally to the 4-pin system sockets at the CP-44 front panel (Sub signals on 1+/1- and mid/high signals on 2+/2-).

Mains power is provided by the 16 A CEE plug on the front panel and the 4 Schuko sockets at the rear (L1 – sub-amp, L2 – mid/high amp and controller, L3 – free).

The XLR In/Out sockets on the front for RS-485 control are connected internally to the DSP 244 and after conversion of the controller allow the rack to be controlled remotely from a PC using CrossMax editor software.

In the **CSR-4**, the controller operates in mono 4-way mode and provides the lower L 2400 with a sub signal on Channel A and a low signal on Channel B. The upper L 2400 is provided with mid signals on Channel A and high signals on Channel B.

The outputs of the power amplifiers are connected to the 4- and 8-pin system sockets of Channel A on the front panel. The complete LF control of the rack is also effected via Channel A.

The Sub signal is available on the 4-pin system sockets on pins 1+/1-. The remaining signals are on the 8-pin system sockets (Low – 2+/2-, Mid – 3+/3- and High – 4+/4-) and drive the stacked or flown TOP and FAR cabinets via a single cable.

RS-485 and AC connectors are also available as described for the CSR-12.

13. FLYING ACCESSORIES

The COBRA SYSTEM components COBRA-SUB, COBRA-TOP, COBRA-4-TOP and COBRA-4-FAR are supplied as standard with 4 vertical integrated ANCRA flying rails (2 x left and 2 x right) and are therefore 'flight-ready' when they leave the factory.

Each flown 'row' is fastened to the truss with 4 x 2" truss clamps (TC-04 # 112 695) and the highest cabinet with 4 x CSST # 112 878 (Cobra System snap truss / 1 x double stud and 1 x hook).

The connection to the cabinets below is effected using 4 x CSSM # 112 873 (Cobra System rigging strap medium / 2 x double stud)

The length of the CSSM should be chosen to ensure that the enclosures are connected flush with each other as well as to allow adjacent enclosures to open at specific angles.

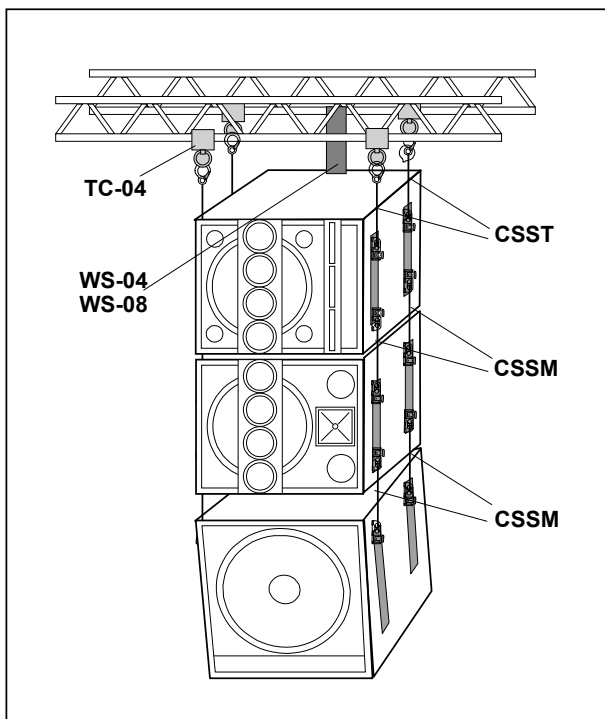

All flight-capable COBRA enclosures are fitted with two flanges on the rear side (above and below) to accept webbing straps.

The available webbing straps: # 112 694 WS 04 (4 metre) and # 112 690 WS 08 (8 metre) are used for the alignment of the complete flown array.

The complete COBRA Flying System consisting of truss clamps, 4 rigging straps CSST / CSSM can be loaded at a safety factor of S=4 with a maximum of 1.6 t.

It must be emphasized that when hanging loudspeaker enclosures, the relevant safety regulations must be adhered to at all times. It is especially important to check the suitability of the points by which the systems are attached to the building. Qualified experts must be consulted at all times.



12. COUNTRY SPECIFIC VERSIONS

SYSTEMS & COMPONENTS	COBRA 100 V	COBRA 120 V	COBRA 230 V	COBRA 240 V	COBRA-4 100 V	COBRA-4 120 V	COBRA-4 230 V	COBRA-4 240 V
	112 884	112 885	112 876	112 886	112 901	112 902	112 903	112 904
COBRA-4-FAR 112 897	----	----	----	----	2	2	2	2
COBRA-4-TOP 112 898	----	----	----	----	4	4	4	4
COBRA -TOP 112 869	4	4	4	4	----	----	----	----
COBRA-PWH 112 895	----	----	----	----	8	8	8	8
COBRA -SUB 112 868	4	4	4	4	----	----	----	----
CSR-12 100 V 112 887	1	----	----	----	----	----	----	----
CSR-12 120 V 112 888	----	1	----	----	----	----	----	----
CSR-12 230 V 112 874	----	----	1	----	----	----	----	----
CSR-12 240 V 112 889	----	----	----	1	----	----	----	----
CSR-4 100 V 112 905	----	----	----	----	2	----	----	----
CSR-4 120 V 112 906	----	----	----	----	----	2	----	----
CSR-4 230 V 112 907	----	----	----	----	----	----	2	----
CSR-4 240 V 112 908	----	----	----	----	----	----	----	2
CSW 25 112 877	1	1	1	1	2	2	2	2
PSS 401 112 676	4	4	4	4	----	----	----	----
PSS 404 112 677	2	2	2	2	4	4	4	4
PSS 408 112 678	----	----	----	----	4	4	4	4
PSS 415 112 679	2	2	2	2	----	----	----	----
PSS 801 112 680	----	----	----	----	4	4	4	4
PSS 808 112 682	----	----	----	----	2	2	2	2
AMP RACKS & COMPONENTS	CSR-12 100 V	CSR-12 120 V	CSR-12 230 V	CSR-12 240 V	CSR-4 100 V	CSR-4 120 V	CSR-4 230 V	CSR-4 240 V
CONTROLLER *	DSP 244 112 697	DSP 244 112 697	DSP 244 112 697	DSP 244 112 697	DSP 244 112 697	DSP 244 112 697	DSP 244 112 697	DSP 244 112 697
AMPLIFIER L2400	2x 100 V 112 881	2x 120 V 112 865	2x 230 V 112 546	2x 240 V 112 883	2x 100 V 112 881	2x 120 V 112 865	2x 230 V 112 546	2x 240 V 112 883
CONN. PANEL **	CP-44-EX 112 890	CP-44-EX 112 890	CP-44 112 871	CP-44-EX 112 890	CP-84-EX 112 900	CP-84-EX 112 900	CP-84 112 696	CP-84-EX 112 900
XLR-CABLES	4x MXX 1 112 872	4x MXX 1 112 872	4x MXX 1 112 872	4x MXX 1 112 872	4x MXX 1 112 872	4x MXX 1 112 872	4x MXX 1 112 872	4x MXX 1 112 872
FLIGHT-CASE	CSF-12 112 875	CSF-12 112 875	CSF-12 112 875	CSF-12 112 875	CSF-12 112 875	CSF-12 112 875	CSF-12 112 875	CSF-12 112 875
* = COBRA : FIRMWARE 2.04 / COBRA-4 : Firmware 2.05				** = CP 84 VERSION incl. 61 / 02 (RS-485)				

COBRA-SYSTEM & COBRA-4-SYSTEM ACCESSORIES

Part No.	TYPE	DESCRIPTION
# 112 877	CSW 25	WEDGE-SET (2x 2,5°)
# 112 695	TC 04	TRUSS-CLAMP 2" / M10 RING
# 112 878	CSST	RIGGING STRAP > TRUSS
# 112 873	CSSM	RIGGING STRAP > CABINET
# 112 694	WS 04	WEBBING STRAP 4,0 m
# 112 690	WS 08	WEBBING STRAP 8,0 m
# 112 461	PCL 880	POLE STAND 880 mm
# 112 726	PSF 201	CABLE SPEAKON > AMP (CP-PANEL)
# 112 875	CSF 12	FLIGHT CASE BLACK, 12 HU
# 163 095	SNAKE - BIG	STICKER "SNAKE-BIG"
# 163 096	DC - COBRA	STICKER "DC-COBRA"

11. TECHNICAL SPECIFICATIONS

SYSTEMS	COBRA-SYSTEM		COBRA-4-SYSTEM		
	COBRA-SUB	COBRA-TOP	COBRA-PWH	COBRA-4-TOP	COBRA-4-FAR
TYPE	COBRA-SUB	COBRA-TOP	COBRA-PWH	COBRA-4-TOP	COBRA-4-FAR
ORDER No	112 868	112 869	112 895	112 898	112 897
CABINET	SUBWOOFER	MID-HIGH CAB.	SUBWOOFER	MID-HIGH CAB.	MID-HIGH CAB.
CABINET TYPE	VENTED	PASSIVE 3-WAY	HORN LOADED	ACTIVE 3-WAY	ACTIVE 3-WAY
IMPEDANCE	8 OHMS	8 OHMS	8 OHMS	-----	-----
LO-MID-HIGH	-----	-----	-----	8 - 8 - 8 OHMS	8 - 8 - 8 OHMS
RATED POWER RMS	600 WATTS	600 WATTS	600 WATTS	-----	-----
LO-MID-HIGH (WATTS)	-----	-----	-----	400 - 200 - 200	400 - 200 - 200
PROGRAM POWER	1200 WATTS	1200 WATTS	1200 WATTS	-----	-----
LO-MID-HIGH (WATTS)	-----	-----	-----	800 - 400 - 400	800 - 400 - 400
SPL 1 WATT / 1 M	98 dB	100 dB	101 dB	100 dB	100 dB
max. SPL / 1 M	129 dB	131 dB	132 dB	131 dB	131 dB
FREQ. RANGE (-10dB)	38Hz - 300Hz	50Hz - 15kHz	38Hz - 160Hz	50Hz - 15kHz	50Hz - 15kHz
DISP. ANGLE 1kHz (-6dB)	-----	H 120° x V 30°	-----	H 120° x V 30°	H 120° x V 30°
DISP. ANGLE 10kHz (-6dB)	-----	H 90° x V 40°	-----	H 90° x V 40°	H 90° x V 5°
INT. PASS. X-OVER	-----	700Hz - 4kHz	-----	-----	-----
REC. ACTIVE X-OVER	124 Hz	124 Hz	124 Hz	124Hz-700Hz-4kHz	124Hz-700Hz-4kHz
VOICE COIL PROT.	SUB	LOW-MID-HIGH	SUB	LOW-MID-HIGH	LOW-MID-HIGH
COMPONENTS HIGH	-----	DH 2T / HPT 94	-----	DH 2T / HPT 94	DH2T LINE ARRAY
ORDER #	-----	355 391 / 357 979	-----	355 391 / 357 979	3x 355 391
COMPONENTS MID	-----	C8 LINE ARRAY	-----	C8 LINE ARRAY	C8 LINE ARRAY
ORDER #	-----	4x 361 376	-----	4x 361 376	4x 361 376
COMPONENTS LOW	-----	DL 15 Y	-----	DL 15 Y	DL 15 Y
ORDER #	-----	361 142	-----	361 142	361 142
COMPONENTS SUB	EVX 180 B	-----	EVX 180 B	-----	-----
ORDER #	349 397	-----	349 397	-----	-----
CONNECTORS FR	-----	4-pole 1+/1-	-----	-----	-----
CONN. HIGH	-----	"SYSTEM" 4-pole 2+/2-	-----	8-pole 4+/4-	8-pole 4+/4-
CONN. MID	-----		-----	8-pole 3+/3-	8-pole 3+/3-
CONN. LOW	-----		-----	8-pole 2+/2-	8-pole 2+/2-
CONN. SUB	4-pole 1+/1-	-----	4+8-pole 1+/1-	-----	-----
DIMENSIONS mm (WxHxD)	600 x 615 x 717	600 x 495 x 717	600 x 915 x 826	600 x 495 x 717	600 x 495 x 717
% WHEELS & COVER	600 x 600 x 589	600 x 600 x 589	600 x 900 x 680	600 x 600 x 589	600 x 600 x 589
WEIGHT	53,0 kg	56,0 kg	65,0 kg	51,5 kg	58,5 kg
CABINET	18 mm	18 mm	18 mm	18 mm	18 mm
STYLE	BIRCH PLYWOOD	BIRCH PLYWOOD	BIRCH PLYWOOD	BIRCH PLYWOOD	BIRCH PLYWOOD
OUTFIT	BLACK	BLACK	BLACK	BLACK	BLACK
COATING	POLYURETHANE	POLYURETHANE	POLYURETHANE	POLYURETHANE	POLYURETHANE
STEEL GRILLE	POWDER COATED	POWDER COATED	POWDER COATED	POWDER COATED	POWDER COATED
HANDLES	2 pcs.	2 pcs.	6 pcs.	2 pcs.	2 pcs.
CASTORS	4x 100mm	4x 100mm	4x 100mm	4x 100mm	4x 100mm
WARRANTY	36 MONTHS	36 MONTHS	36 MONTHS	36 MONTHS	36 MONTHS



cobra
DYNACORD®